

# Camper van trip

## Listening to nature

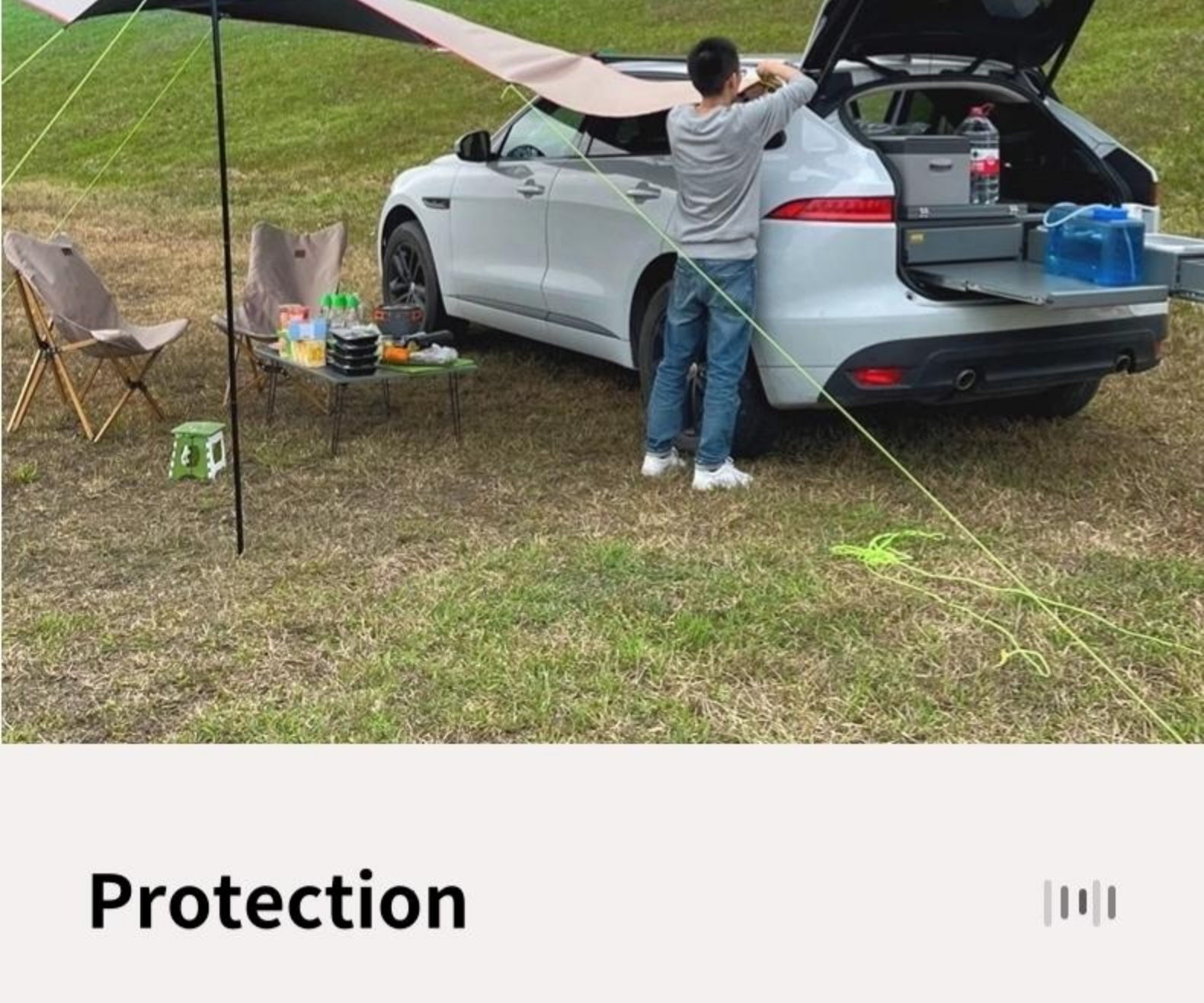

### Protection



High-quality products for an enhanced road trip experience



Custom-made for specific vehicles



Non-destructive installation



Comfortable bed



Aluminum material



Fully equipped



Easy to disassemble



Eco-friendly coating



Exquisite craftsmanship

When inquiring Please specify the vehicle model and year

## Single-Mode Car Camping Box

Your perfect travel companion—effortless and carefree solo adventures!

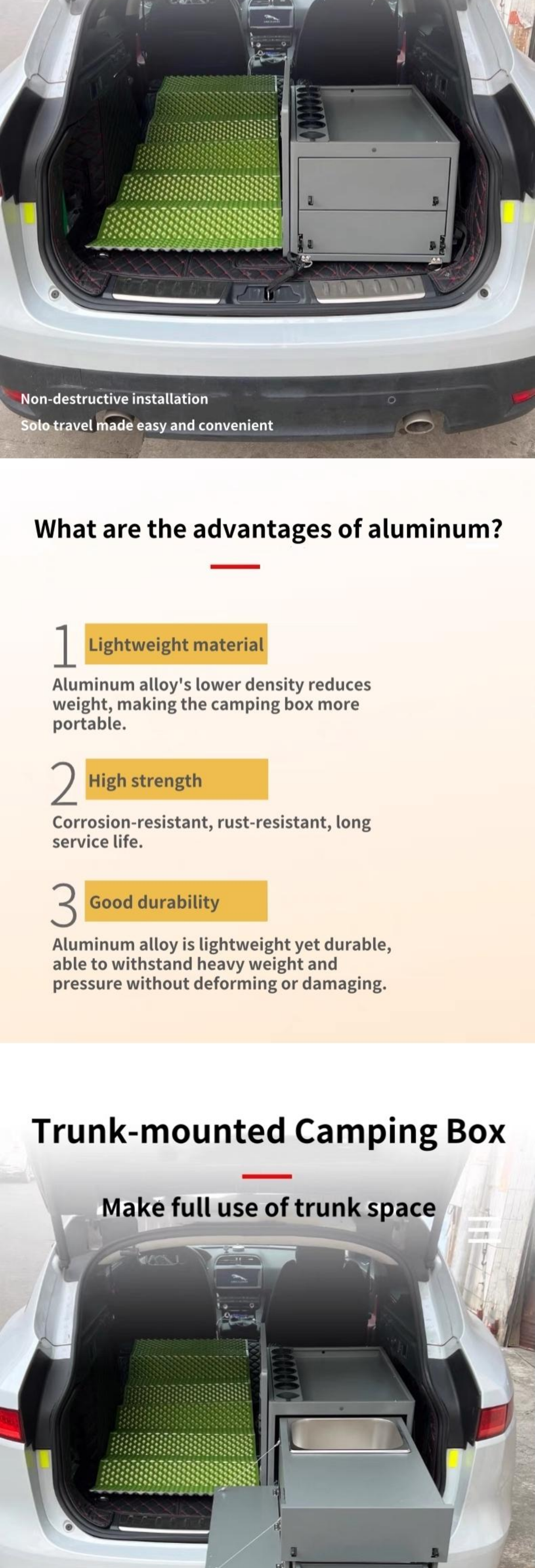

Non-destructive installation

Solo travel made easy and convenient

### What are the advantages of aluminum?

#### 1 Lightweight material

Aluminum alloy's lower density reduces weight, making the camping box more portable.

#### 2 High strength

Corrosion-resistant, rust-resistant, long service life.

#### 3 Good durability

Aluminum alloy is lightweight yet durable, able to withstand heavy weight and pressure without deforming or damaging.

## Trunk-mounted Camping Box

Make full use of trunk space



Lightweight and easy to load

## Outdoor mini kitchen

Simple and practical even on one side



### Storage area

Neat and organized, with space for a refrigerator and spice bottles.

### Pull-out sink area

Equipped with a stainless steel basin and electric water pump for easy water access.



### Storage drawer

Stores utensils, compact storage space.

### Cooking area

Fixed gas stove safety slot, folding windscreen to block grease and wind.



### Storage area

Lift the cover at the gas stove position to reveal a small storage compartment.

# Ideal for all-day meals

Live and dine in the car, with full functionality



## Drawer with lock function

Designed for stability and safety  
Ensuring the drawer stays secure during use

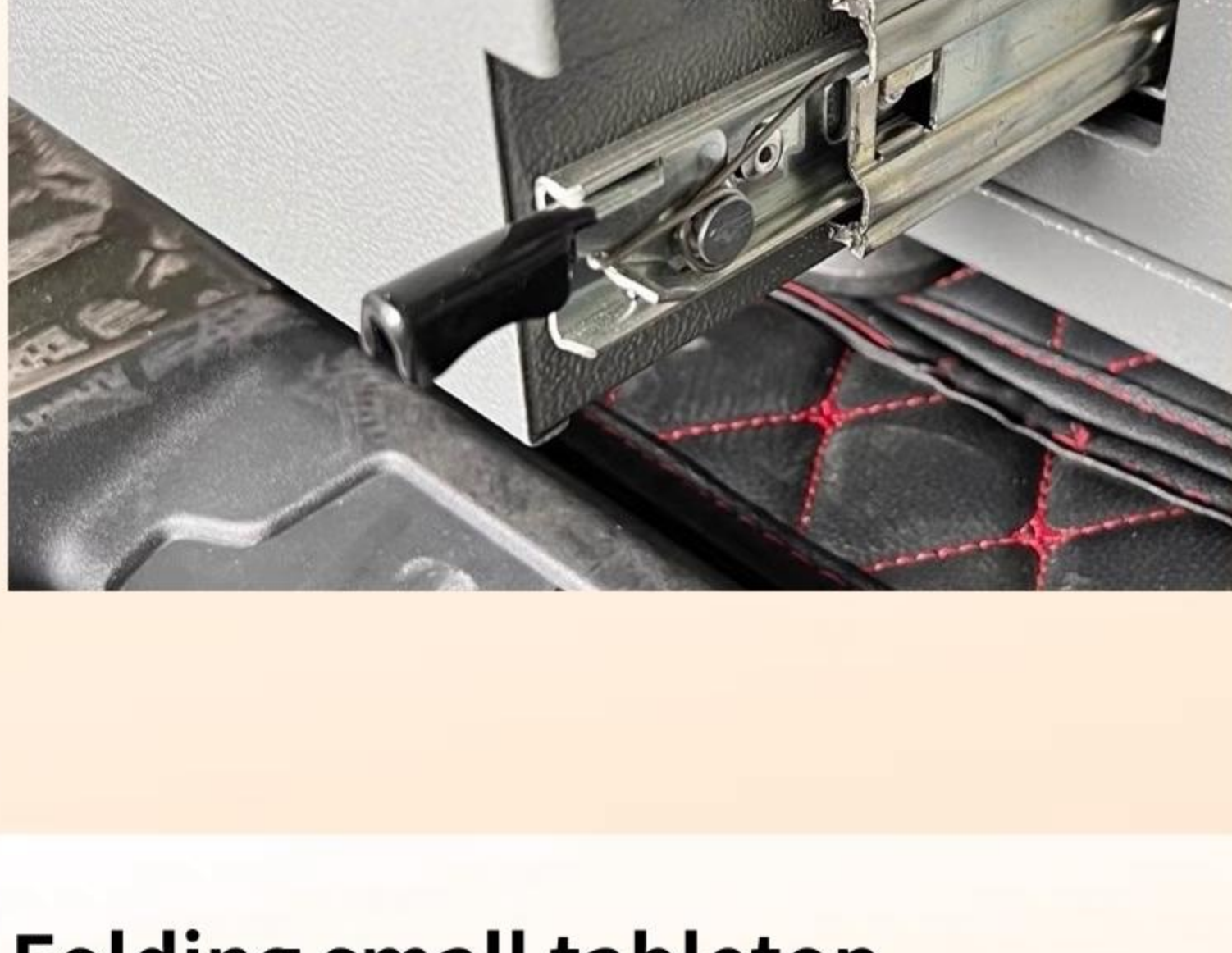

## Folding small tabletop

Two-minute storage, simple and hassle-free

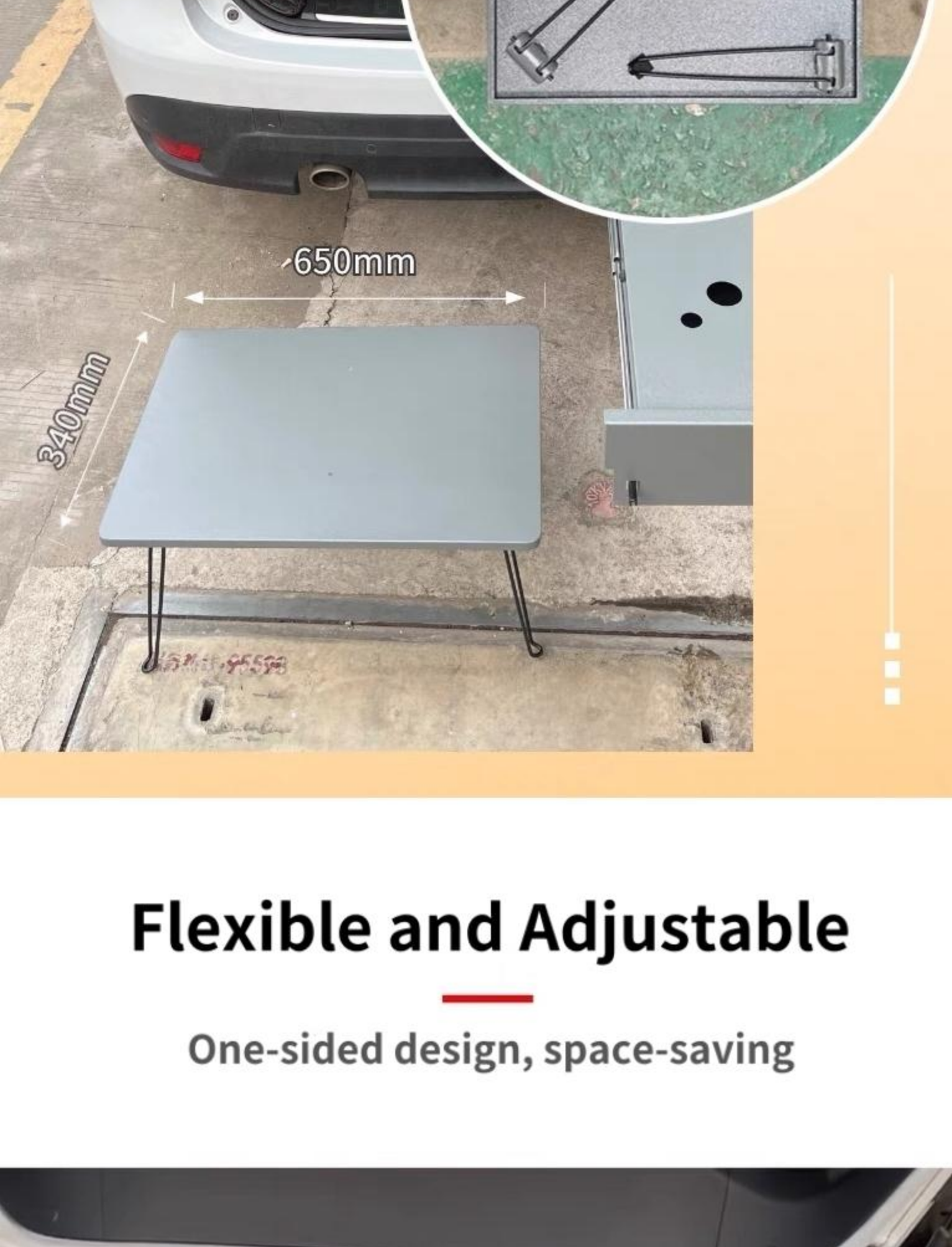

## Flexible and Adjustable

One-sided design, space-saving

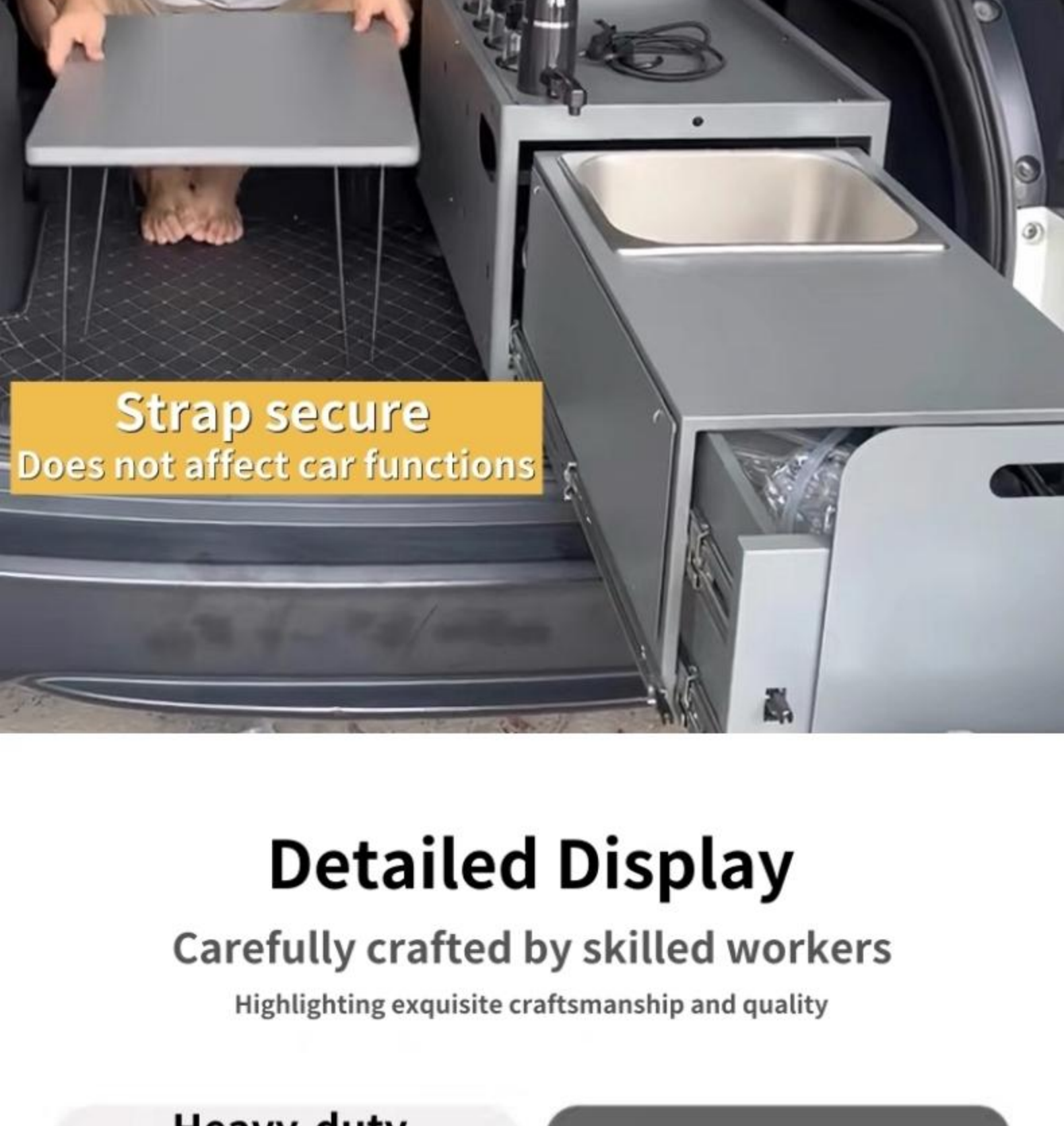

## Detailed Display

Carefully crafted by skilled workers

Highlighting exquisite craftsmanship and quality

### Heavy-duty industrial rails



### Standard market rails



### 01 High-temperature powder coated

Eco-friendly, odorless, with powder coating and high-temperature baking for corrosion resistance and a smooth finish.

### 02 Semi-arc bending process

The semi-arc bending process greatly reduces the risk of accidental scratches or cuts, ensuring higher safety.

### 03 Laser spot welding process

Achieves highly precise welding with minimal seam gaps and superior quality.

### 04 Precision grinding and polishing process

The surface is polished to remove burrs, making it smoother and more even, achieving a higher gloss and smoothness.

## Product Features Showcase

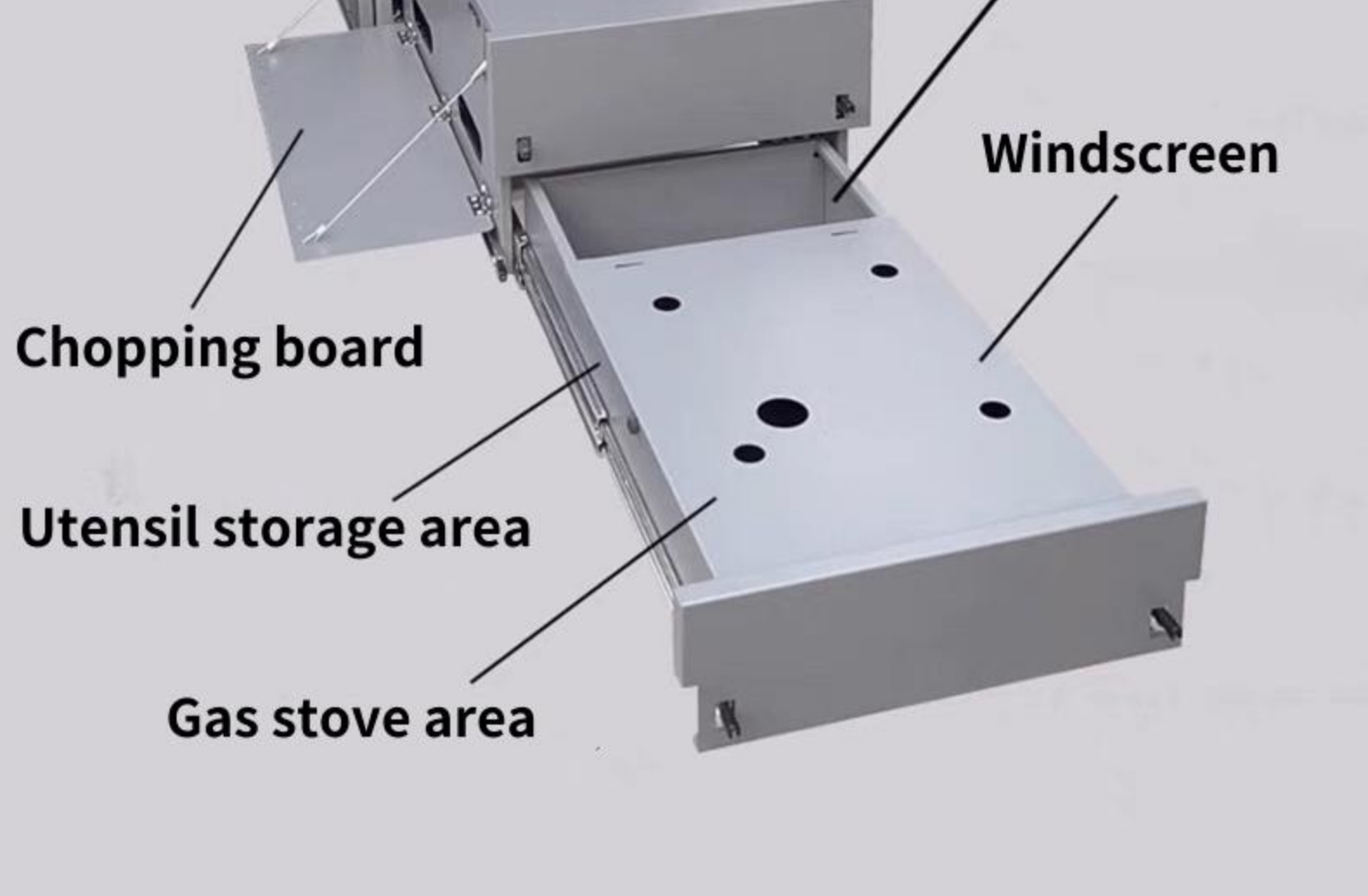

# Product Specifications

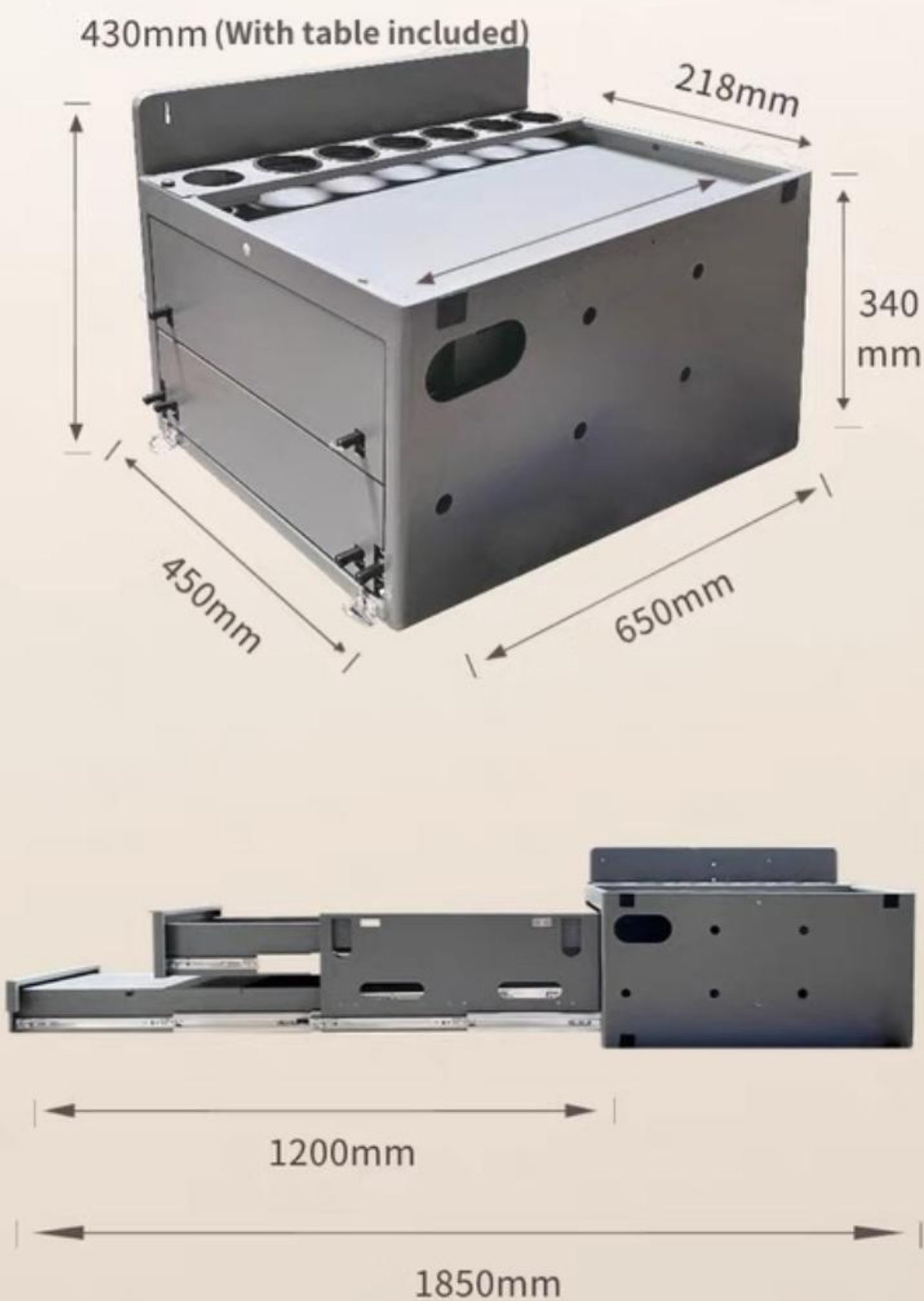

<b>Product Name</b>	<b>Single-person Camping Box</b>
<b>Material</b>	<b>Aluminum / Galvanized Steel</b>
<b>Product Size</b>	<b>450mm*650mm*340mm (length x depth x height)</b>
<b>Net Weight</b>	<b>Aluminum: 23kg / Galvanized Steel: 28kg</b>

# Packaging Specifications



<b>Packaging Dimensions</b>	<b>770mm*570mm*540mm (length x width x height)</b>
-----------------------------	--